

KEB



COMBIVERT F6

DRIVE CONTROLLER 4 ... 400 kW
EN



CONTENT

PAGE

System overview	3
Benefits at a glance	4
COMBIVERT F6 Versions	6
Functional Safety	8
Technical data	10
Combivis 6	12
Accessories	14
KEB worldwide	15

SYSTEM OVERVIEW

Automation with Drive

stands as a synonym for optimally selected combinations of control and automation solutions with the drive level at the end it is the key to successful machine concepts.

Let the following pages inspire you with regards to the diversity and performance of the COMBIVERT F6 drive controller, and help you to find a solution that reliably meets your requirements.

SOFTWARE

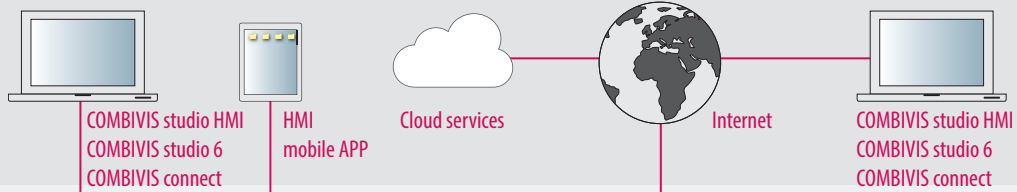

HMI

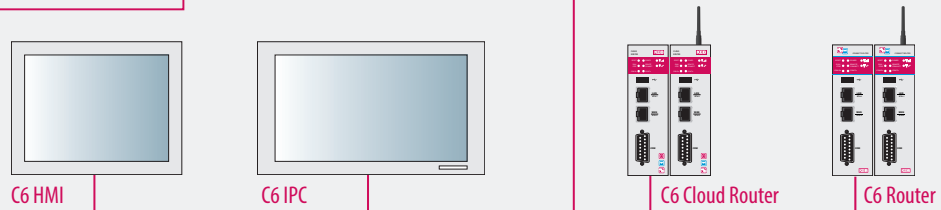

CONTROL

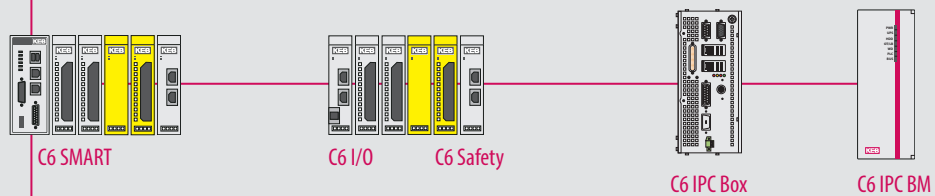

DRIVES

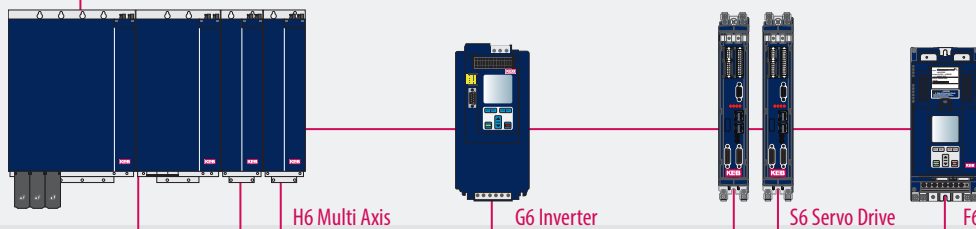

MOTORS

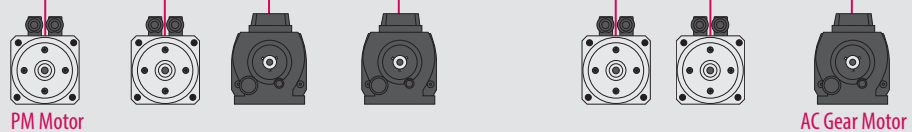

OPTIMALLY SELECTED COMPONENTS

Flexibility, functionality, efficiency and cost-effectiveness are the key requirements for today's drive system. The single axis drive controller COMBIVERT F6, in the power range from 4 to 400 kW is covering these requirements and is a perfect extension of the KEB drive portfolio.

The COMBIVERT F6 with its capability to operate different motor types, the various real-time communication to higher-level controllers, the choice of integrated Safety function modules or the cooling concept is the perfect drive controller for every machine. The intuitive PC tool COMBIVIS 6 makes the newly developed KEB drive platform easy to handle.

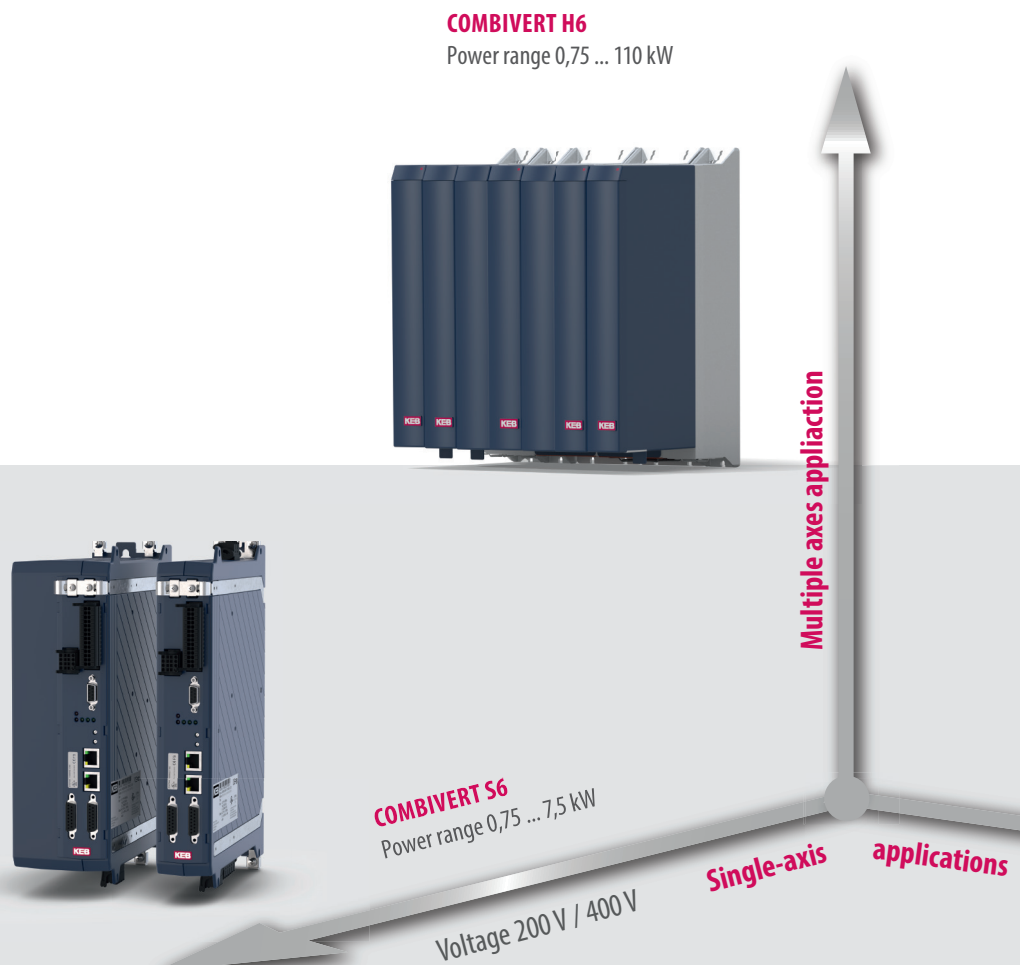

DRIVE BASED SAFETY

- Integrated Safety functionality
- Basic function STO in System version
- Additional High Level Safety in Application version
- Encoderless safety in version PRO

REAL - TIME COMMUNICATION

or simply serially

- Real-time Ethernet-based interfaces
- CAN
- RS232/485 for diagnostics or display

ALL IN ONE - UNIVERSAL MOTOR OPERATIONS

- Control for synchronous, asynchronous, IPM or synchronous reluctance motors
- Motor operation with encoder feedback or encoderless ASCL/SCL for precise speed control
- Motor temperature monitoring with PTC, KTY or PT1000 sensors
- Two-channel multi-encoder interface
- Integrated GTR7 brake transistor
- Integrated brake control and brake supply

ANALOG & DIGITAL I/O

supports actual machine concepts with

- 8 digital and 2 analog inputs
- 2 digital and 1 relay output
- 1 Analog output 0 ... 10 V



COMBIVERT F6
Power range 4 ...400 kW

Voltage 400 V

**HIGHLIGHTS**

- Uncompromising integration, highest performance
- Modern realtime communication standards
- Integrated functional safety
- Particular compact size
- Modular design, flexible cooling systems

COMBIVERT F6 - VERSIONS

FUNCTIONAL SAFETY

INTERFACES

CAN interface
Realtime Ethernet

LCD DISPLAY

LCD Operator
Ethernet Operator
USB Operator

KTY/PTC/PT1000 EVALUATION

BRAKE CONTROL 24 V / 2 A

MAINS CONNECTIONS

I/O

8 digital inputs
2 digital outputs
1 relay
2 analog inputs
1 analog output
24V DC supply

STATUS LEDS

DIAGNOSTIC INTERFACE

MULTI ENCODER INTERFACES

Resolver, EnDAT, HIPERFACE, BISS, SSI,
Incremental HTL/TTL,
Incremental output

MOTOR TERMINALS

DC SUPPLY TERMINALS

and braking resistor

EtherCAT®

Safety over
EtherCAT®



CANopen®



HIGHLIGHTS

- Universally usable for every motor technology
- Highest performance in torque, speed and position control
- Uncompromising integration
- User-friendly
- Scalable safety functions...

COMPACT
HIGHLY INTEGRATED
AND ECONOMICAL

STO

REALTIME ETHERNET

EtherCAT OR VARAN

Communication interface

CAN

DIAGNOSTIC RS232/485

APPLICATION
MODULAR AND FLEXIBLE

STO, SBC and speed/position related safety functions

REALTIME ETHERNET

EtherCAT
PROFINET
POWERLINK
EtherNet/IP

Communication interface

CAN

DIAGNOSTIC RS232/485

PRO
ENCODERLESS SAFETY

STO, SBC and speed related safety functions without encoder feedback

REALTIME ETHERNET

EtherCAT

Communication interface

CAN

DIAGNOSTIC RS232/485



HIGHLIGHTS

- Brake handling
- Power-off
- DC-brake
- PID controller
- Round table function
- Reciepe management
- Multi motor handling
- Anti cogging
- Management liquide cooling
- Etc.

SAFETY FUNCTIONS IN THE DRIVE

BASIS FOR SAFETY

COMPACT

In the Compact version, the COMBIVERT F6 and S6 drive controllers are equipped with Safe-Torque-Off (STO).

SAFETY FUNCTIONS WITH SPEED AND POSITION MONITORING

APPLICATION

The device variant Application is available in two versions. In addition to STO, Module 1 adds safe brake control (SBC) which provides a safe 24 V supply for the brakes.

Module 3 offers safe motion functionality according to IEC 61800-5-2 through speed and position detection using encoders.

The error reaction time is shortened and costs are reduced by reducing the number of separate protective devices. Module 3 also offers the option of controlling all available safety functions and limit values via Safety over EtherCAT (FSoE).

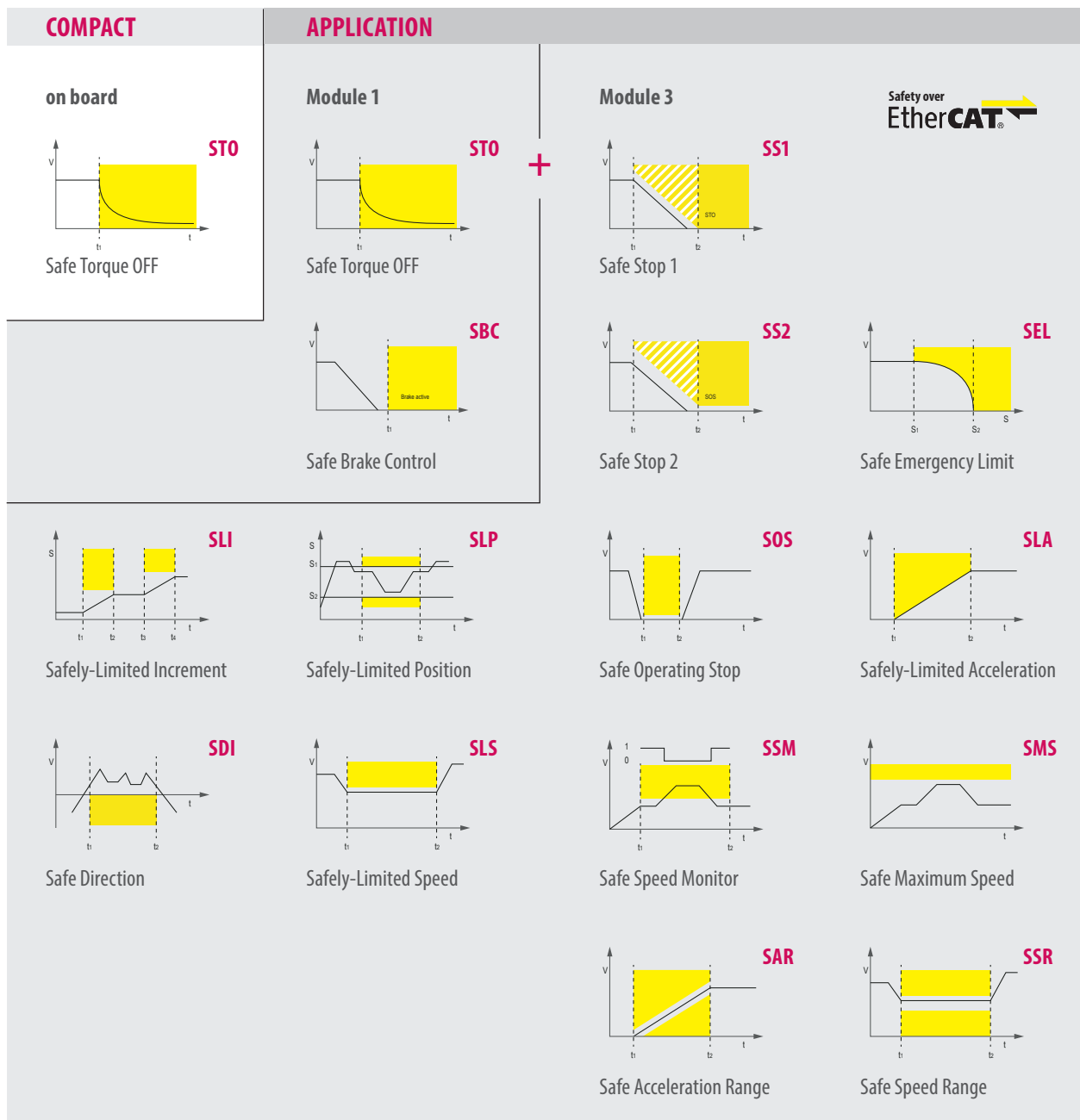

SENSORLESS SAFETY FUNCTIONS

PRO

The Pro device variant of the COMBIVERT F6 and S6 drive controllers offers advanced safety functions without having to use a safety encoder. The device determines the safe velocity parameters from the pulse width modulation (PWM) of the motor supply.

In addition to STO, Module 5 is equipped with a safe brake control (SBC), which provides a safe 24 V supply for braking operation as well as a monitoring of the switching status of the brake via microswitch evaluation.

Module 5 also offers the option of controlling all available safety functions via Safety over EtherCAT (FSoE).

PRO

Module 5

<p>STO</p> <p>Safe Torque OFF</p>	<p>SLS</p> <p>Safely-Limited Speed</p>	<p>SS1</p> <p>Safe Stop 1</p>
<p>SLA</p> <p>Safely-Limited Acceleration</p>	<p>SMS</p> <p>Safe Maximum Speed</p>	<p>SBC</p> <p>Safe Brake Control</p>
<p>SSM</p> <p>Safe Speed Monitor</p>	<p>SDLC</p> <p>Safe Door-Lock Control</p>	



WHY USE DRIVE-BASED SAFETY (SAFE MOTION)?

- Less wiring - remove contactors and other traditional safety components
- Fast reaction - direct handling inside the drive
- Easy to operate - up to 8 different safety setups per function
- Cost savings compared to traditional safety solution

COMBIVERT F6

TECHNICAL DATA

HOUSING		2					3				4		
		12	13	14	15	16	17	18	19	20	20	21	22
Device size		12	13	14	15	16	17	18	19	20	20	21	22
Mains phases		3											
Rated output power	[kVA]	6.6	8.3	11.4	16.6	22.9	29	35	42	52	52	62	76
Typical rated motor power	[kW]	4	5.5	7.5	11	15	18.5	22	30	37	37	45	55
Rated output current 400V	[A]	9.5	12	16.5	24	33	42	50	60	75	75	90	110
Rated output current 480V (UL)	[A]	7.6	11	14	21	27	34	40	52	65	65	77	96
Short-term current limit (60 s / max).	[%]	150 / 216					150 / 180						
Rated input current 400V	[A]	13	17	21	31	43	55	59	66	82	82	99	121
Rated input current 480V (UL)	[A]	11	15	18	27	35	44	48	57	71	71	85	106
Rated switching frequency	[kHz]	8	8	4	4	4	2	2	2 / 4	2	4	2	2
Max. switching frequency	[kHz]	16											
Rated input voltage (AC)	[V]	3-phases 400 (UL: 480)											
Input voltage range (AC)	[V]	280 ... 550 ±0											
Input voltage range (DC)	[V]	390 ... 780 ±0											
Mains frequency	[Hz]	50 / 60 ±2											
Output voltage	[V]	3 x 0 ... U _{IN}											
Output frequency	[Hz]	0 ... 599 optional 0 ... 2000											

FLEXIBLE COOLING FOR DIFFERENT APPLICATIONS

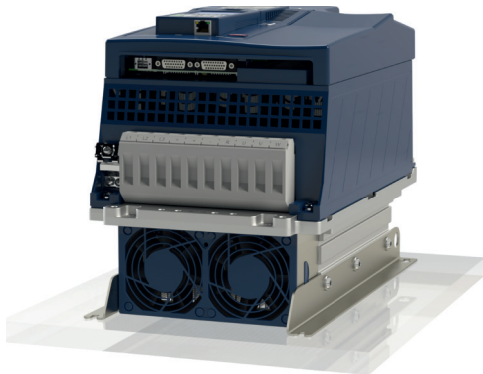

In-built version air cooling



Through mount version air cooling



In-built version liquid-cooling with stainless steel pipes



Through mount version liquid-cooling with stainless steel pipes

HOUSING		6				7*			8				9*		
Device size		21	22	23	24	25	26	27	27	28	29	30	30	31	32
Mains phases		3													
Rated output power	[kVA]	62	80	104	125	145	173	208	208	256	319	395	395	436	492
Typical rated motor power	[kW]	45	55	75	90	110	132	160	160	200	250	315	315	355	400
Rated output current 400V	[A]	90	115	150	180	210	250	300	300	370	460	570	570	630	710
Rated output current 480V (UL)	[A]	77	96	124	156	180	210	240	240	302	414	477	477	515	590
Short-term current limit (60 s / max).	[%]	150 / 180				125 / 150									
Rated input current 400V	[A]	99	126	158	189	221	263	315	315	390	485	600	600	660	745
Rated input current 480V (UL)	[A]	85	106	128	162	186	218	249	249	313	429	494	494	533	611
Rated switching frequency	[kHz]	8	4	2	2	4	4	2	4	4	2	2	4	2	2
Max. switching frequency	[kHz]	16													
Rated input voltage (AC)	[V]	3-phases 400 (UL: 480)													
Input voltage range (AC)	[V]	280 ... 550 ±0													
Input voltage range (DC)	[V]	390 ... 780 ±0													
Mains frequency	[Hz]	50 / 60 ±2													
Output voltage	[V]	3 x 0 ... U _{IN}													
Output frequency	[Hz]	0 ... 599 (optional 0 ... 2000)													

HOUSING	H** (mm)	W** (mm)	D** (mm)	AIR COOLING		LIQUID COOLING	
				in-built	through mount	in-built	through mount
2	290	130	240	X	X	-	-
3	340	170	261	X	X	-	-
4	375	224	272	X	X	X	X
6	525	249	272	X	X	X	X
7*	570	336	360	X	X	X	X
8*	860	336	360	X	X	X	X
9*	960	503	360	X	X	X	X

* in preparation

** air cooled in-built version

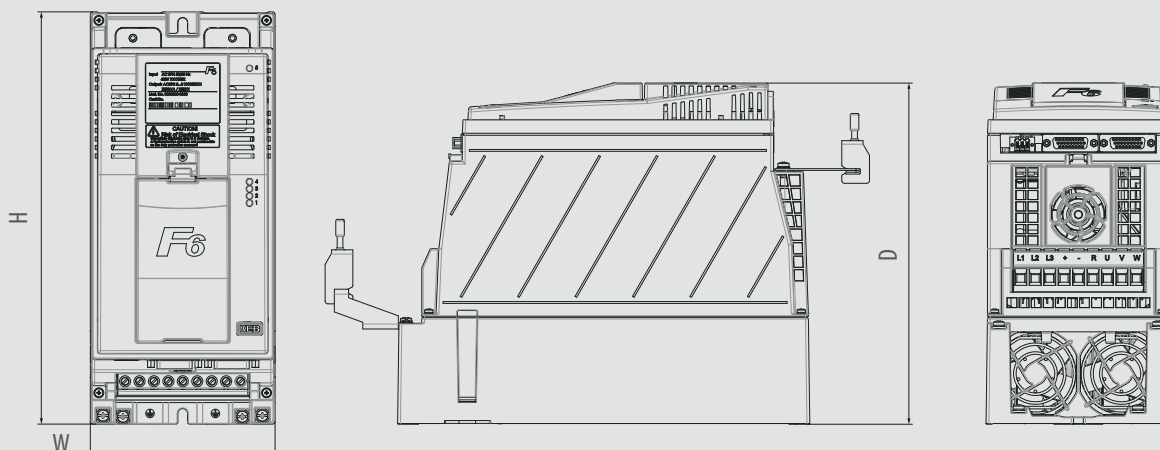

COMBIVIS 6

- Free and easy-to-use software for startup, administration and analysis
- Integrated start-up assistants (Wizards) for quick and easy configuration
- Direct access to device documentation
- 16 channel oscilloscope for extensive analysis
- Online parameter list comparison
- Parameterisation of key safety indicators and functions

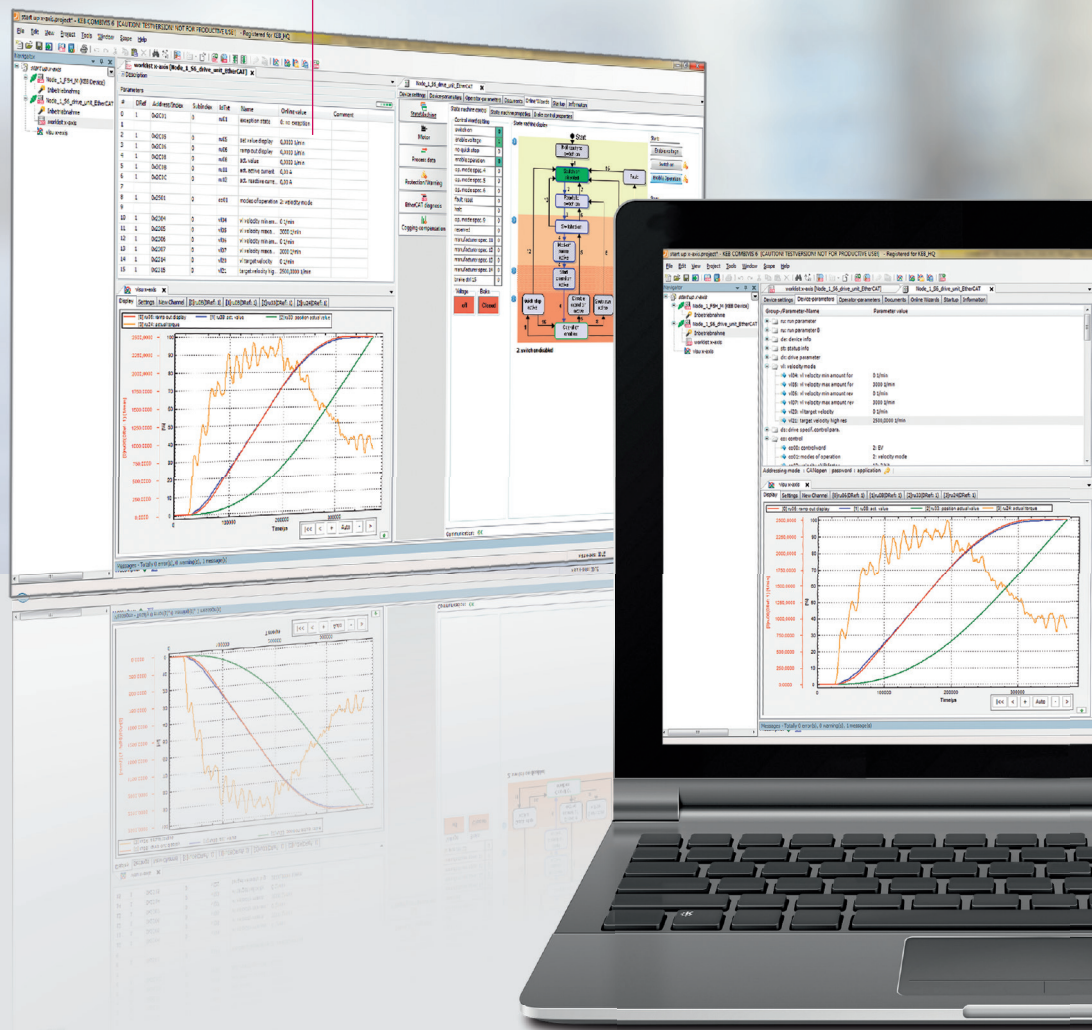

COMBIVIS studio 6

The intelligent automation suite from KEB combines an assistant-guided component selection, fieldbus configuration, drive parameterisation, IEC 61131-3 project generation and motion control. Throughout the planning and layout phase, implementation of control sequences and multi-axis movement profiles, to start-up and fine tuning, the user is supported by a tool developed by experienced application engineers.

With a foundation built on libraries, devices and template databases, rapid and simple solutions can be generated for a wide range of applications.

COMMISSIONING ASSISTANT

- Complete user guidance through the commissioning process
- KEB Motor database, free for extensions
- Anti cogging
- Fieldbus diagnostic and optimisation

SYSTEM CONFIGURATION AS A NEW COMPONENT OF COMBIVIS

- Access to complete KEB product database
- Intuitive gear component selection and system configuration using drag and drop
- Selection assistant with display of compatible components
- Display of all interfaces and connection components
- Material number generator
- Extensive export function for quote list, Combivis Project, Excel ...

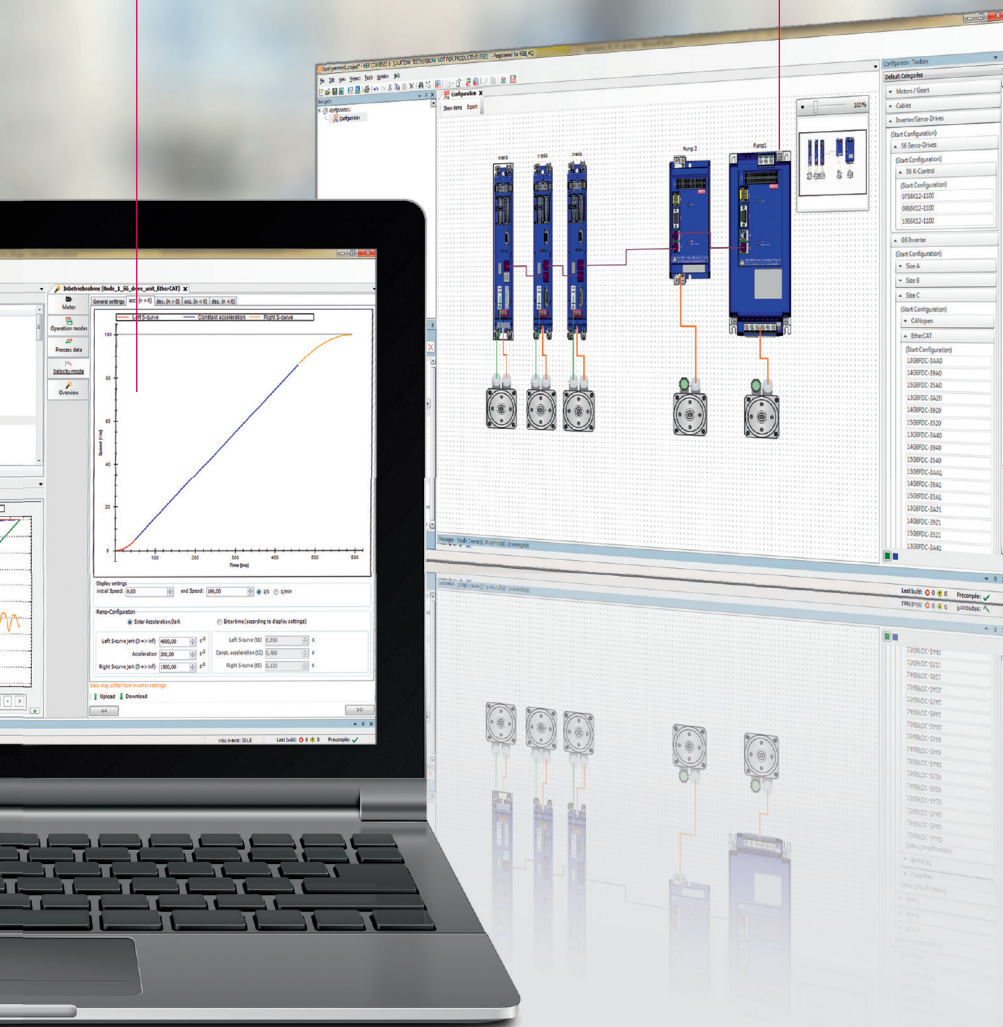

HIGHLIGHTS

- IEC 61131-3 Applications development
- Device and library database
- Product configuration
- Start-up and diagnosis assistant
- COMBIVIS studio HMI integration
- Document database

ACCESSORIES

STABLE OPERATION IN INDUSTRIAL ENVIRONMENT

An EMC-compliant assembly with efficient control cabinet and suppression system is the basis for safe operation of machinery and equipment. The current and voltage limiting COMBILINE modules are optimally designed to meet the requirements of the COMBIVERT F6 drive controller series and support the use through:

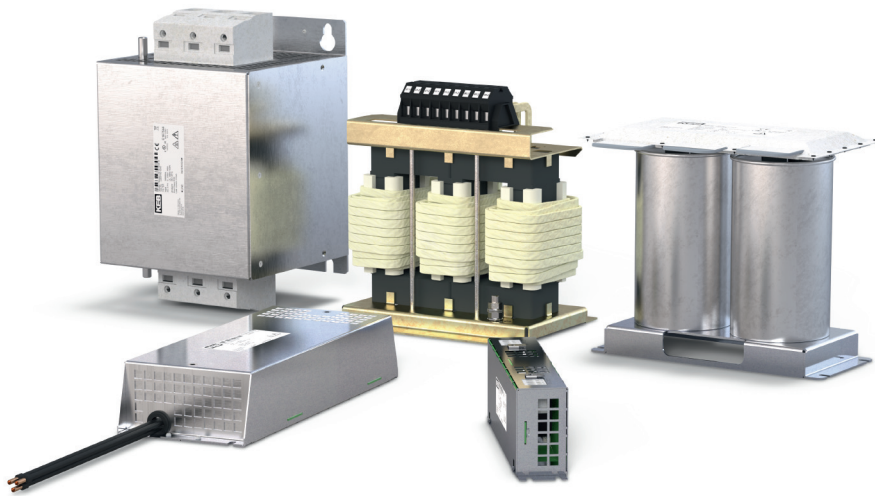

MAINS EMC FILTERS

Reduce the cable-fed emission to the required limits IEC 61800-3 - C1/C2. Further variants offer low leakage currents or the operation of special mains networks.

MAINS CHOKE

Reduce the input peak current draw and the mains distortion. By smoothing the input current draw, the lifetime of the drive is enhanced, in particular at constantly high utilization.

OUTPUT CHOKES AND FILTERS

Reduce the voltage and current stress of the motor winding.

COMBI FILTERS (EMC / OUTPUT CHOKE)

Space-saving combination, consistently adapted and optimised to the drive controller.

SINE-WAVE FILTERS

Protect the motor winding from voltage peaks and allow the use of long motor cables.

HARMONIC FILTERS

Reduce the low frequency mains distortion of B6-rectifier supplied devices. These harmonic filters are the new innovative solution to comply to most international standards. The integration to a switch gear layout is as simple as of mains chokes.

SINE-WAVE EMC FILTERS

Allow operation of motors with long motor cables even without screening.

HIGH PERFORMANCE FERRITE CORES

Reduces the values of du/dt 's also in the frequency range of the bearing currents.

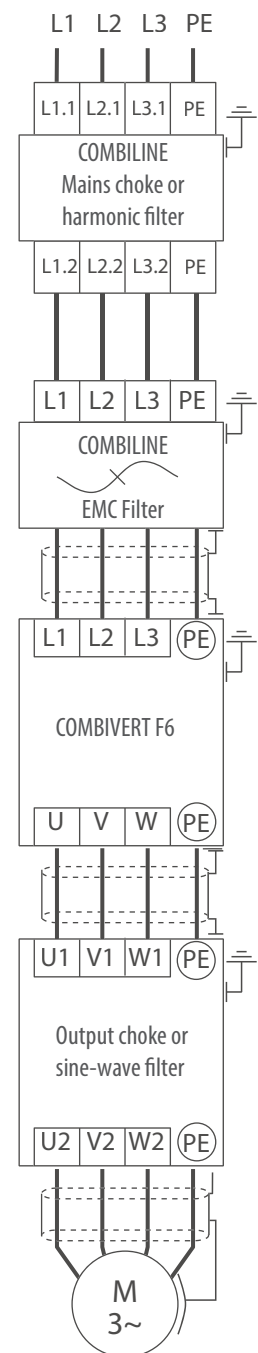

KEB WORLDWIDE

Austria | KEB Automation GmbH

Ritzstraße 8 4614 Marchtrenk Austria
 Tel: +43 7243 53586-0 Fax: +43 7243 53586-21
 E-Mail: info@keb.at Internet: www.keb.at

Belgium | KEB Automation KG

Herenveld 2 9500 Geraardsbergen Belgium
 Tel: +32 544 37860 Fax: +32 544 37898
 E-Mail: vb.belgien@keb.de Internet: www.keb.de

Brazil | KEB South America – Regional Manager

Rua Dr. Omar Pacheco Souza Riberio, 70
 BR-CEP 13569-430 Portal do Sol, São Carlos Brazil
 Tel: +55 16 31161294 E-Mail: roberto.arias@keb.de

France | Société Française KEB SASU

Z.I. de la Croix St. Nicolas 14, rue Gustave Eiffel
 94510 La Queue en Brie France
 Tel: +33 149620101 Fax: +33 145767495
 E-Mail: info@keb.fr Internet: www.keb.fr

Germany | **Headquarters**

KEB Automation KG
 Suedstraße 38 32683 Bartrup Germany
 Telefon +49 5263 401-0 Fax +49 5263 401-116
 E-Mail: info@keb.de Internet: www.keb.de

Germany | **Geared Motors**

KEB Antriebstechnik GmbH
 Wildbacher Straße 5 08289 Schneeberg Germany
 Telefon +49 3772 67-0 Fax +49 3772 67-281
 E-Mail: info@keb-drive.de Internet: www.keb-drive.de

Italy | KEB Italia S.r.l. Unipersonale

Via Newton, 2 20019 Settimo Milanese (Milano) Italia
 Tel: +39 02 3353531 Fax: +39 02 33500790
 E-Mail: info@keb.it Internet: www.keb.it

Japan | KEB Japan Ltd.

15 - 16, 2 - Chome, Takanawa Minato-ku
 Tokyo 108 - 0074 Japan
 Tel: +81 33 445-8515 Fax: +81 33 445-8215
 E-Mail: info@keb.jp Internet: www.keb.jp

P. R. China | KEB Power Transmission Technology (Shanghai) Co. Ltd.

No. 435 QianPu Road Chedun Town Songjiang District
 201611 Shanghai P. R. China
 Tel: +86 21 37746688 Fax: +86 21 37746600
 E-Mail: info@keb.cn Internet: www.keb.cn

Republic of Korea | KEB Automation KG

Room 1709, 415 Missy 2000 725 Su Seo Dong
 Gangnam Gu 135- 757 Seoul Republic of Korea
 Tel: +82 2 6253 6771 Fax: +82 2 6253 6770
 E-Mail: vb.korea@keb.de Internet: www.keb.de

Russian Federation | KEB RUS Ltd.

Lesnaya str, house 30 Dzerzhinsky MO
 140091 Moscow region Russian Federation
 Tel: +7 495 6320217 Fax: +7 495 6320217
 E-Mail: info@keb.ru Internet: www.keb.ru

Spain | KEB Automation KG

c / Mitjer, Nave 8 - Pol. Ind. LA MASIA
 08798 Sant Cugat Sesgarrigues (Barcelona) Spain
 Tel: +34 93 8970268 Fax: +34 93 8992035
 E-Mail: vb.espana@keb.de Internet: www.keb.de

Switzerland | KEB Automation AG

Witzbergstraße 24 8330 Pfaeffikon/ZH Switzerland
 Tel: +41 43 2886060 Fax: +41 43 2886088
 E-Mail: info@keb.ch Internet: www.keb.ch

United Kingdom | KEB (UK) Ltd.

5 Morris Close Park Farm Industrial Estate
 Wellingborough, Northants, NN8 6 XF United Kingdom
 Tel: +44 1933 402220 Fax: +44 1933 400724
 E-Mail: info@keb.co.uk Internet: www.keb.co.uk

United States | KEB America, Inc.

5100 Valley Industrial Blvd. South
 Shakopee, MN 55379 United States
 Tel: +1 952 2241400 Fax: +1 952 2241499
 E-Mail: info@kebamerica.com Internet: www.kebamerica.com



KEB PARTNERS WORLDWIDE

... www.keb.de/contact/contact-worldwide

The KEB logo consists of the letters 'KEB' in a bold, white, sans-serif font, set against a dark red rectangular background. To the right of this rectangle is another solid dark red rectangle of the same height, creating a horizontal bar.

KEB

The text 'Automation with Drive' is written in a white, bold, sans-serif font, positioned in the lower-left area of the red footer.

Automation with Drive

The website address 'www.keb.de' is written in a white, bold, sans-serif font, positioned in the lower-right area of the red footer.

www.keb.de

A line of contact information in a white, sans-serif font, including the company name, address, country, phone number, and email address.

KEB Automation KG Suedstrasse 38 32683 Bartrup Germany Tel. +49 5263 401-0 E-Mail: info@keb.de

A vertical copyright notice in a white, sans-serif font, rotated 90 degrees counter-clockwise, located in the bottom right corner of the red footer.

© KEB 0000000-51F6 11.2019 Subject to technical alterations!